

NMD2.4mm Interface

ACIF-78

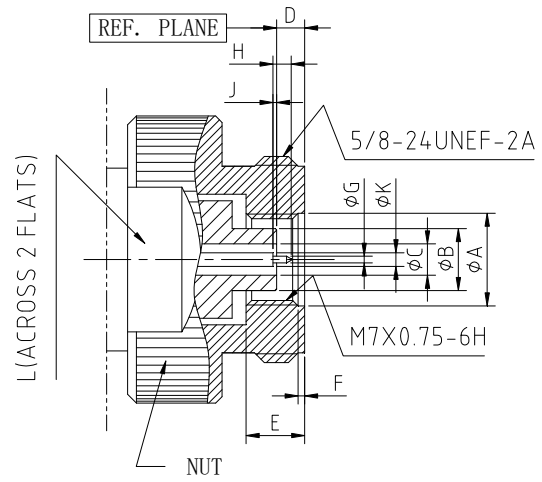
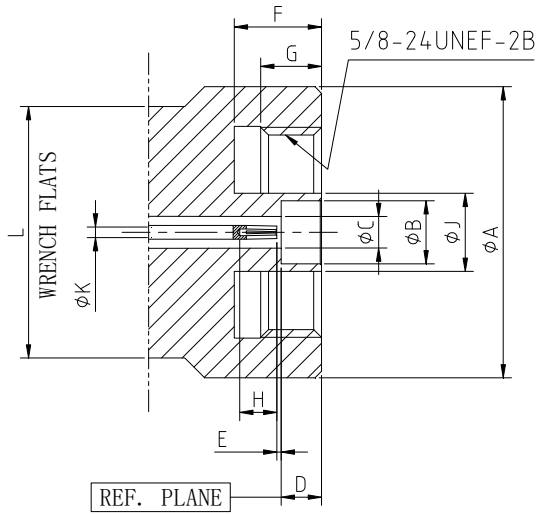

Female				
Ref.	mm		Inch	
	Min.	Max.	Min.	Max.
A	21.80	22.30	0.858	0.878
B	4.770	4.795	0.1878	0.1888
C	2.390	2.410	0.0941	0.0949
D	3.00	3.10	0.118	0.122
E	0.000	0.060	0.0000	0.0024
F	6.50	6.70	0.256	0.264
G	4.50	4.70	0.177	0.185
H	2.80	2.90	0.110	0.114
J	5.79	5.89	0.228	0.232
K	1.030	1.050	0.0406	0.0413
L	19.0		0.75	

Male				
Ref.	mm		Inch	
	Min.	Max.	Min.	Max.
A	7.01	7.11	0.276	0.280
B	4.725	4.750	0.1860	0.1870
C	2.390	2.410	0.0941	0.0949
D	1.95	2.35	0.077	0.093
E	4.40	4.60	0.173	0.181
F	0.51	0.71	0.020	0.028
G	0.500	0.520	0.0197	0.0205
H	1.30	1.50	0.051	0.059
J	0.000	0.060	0.0000	0.0024
K	1.030	1.050	0.0406	0.0413
L	19.0		0.75	